

# Universal AC/DC Photoelectric Sensors



## BX Series PRODUCT MANUAL

For your safety, read and follow the considerations written in the instruction manual, other manuals and Autonics website.

The specifications, dimensions, etc. are subject to change without notice for product improvement. Some models may be discontinued without notice.

### Features

- Built-in sensitivity adjuster
- Timer function (built-in timer model)
  - ON Delay, OFF Delay, One-shot Delay
- NPN/PNP open collector simultaneous output (DC power Type)
- Self-diagnosis function (green lights up in the stable level)
- Built-in reverse power protection circuit and output short overcurrent protection circuit
- Wide power supply range: Universal 24-240 VDC $\equiv$  / 24-240 VAC $\sim$
- IP66 protection rating (IEC standard)

### Safety Considerations

- Observe all 'Safety Considerations' for safe and proper operation to avoid hazards.
- $\Delta$  symbol indicates caution due to special circumstances in which hazards may occur.

**$\Delta$  Warning** Failure to follow instructions may result in serious injury or death.

- 01. Fail-safe device must be installed when using the unit with machinery that may cause serious injury or substantial economic loss. (e.g., nuclear power control, medical equipment, ships, vehicles, railways, aircraft, combustion apparatus, safety equipment, crime/disaster prevention devices, etc.)**  
Failure to follow this instruction may result in personal injury, economic loss or fire.
- 02. Do not use the unit in the place where flammable/explosive/corrosive gas, high humidity, direct sunlight, radiant heat, vibration, impact or salinity may be present.**  
Failure to follow this instruction may result in explosion or fire.
- 03. Do not disassemble or modify the unit.**  
Failure to follow this instruction may result in electric shock or fire.
- 04. Do not connect, repair, or inspect the unit while connected to a power source.**  
Failure to follow this instruction may result in electric shock or fire.
- 05. Check 'Connections' before wiring.**  
Failure to follow this instruction may result in electric shock or fire.

**$\Delta$  Caution** Failure to follow instructions may result in injury or product damage.

- 01. Use the unit within the rated specifications.**  
Failure to follow this instruction may result in fire or product damage.
- 02. Use a dry cloth to clean the unit, and do not use water or organic solvent.**  
Failure to follow this instruction may result in electric shock or fire.
- 03. Do not use a load over the range of rated relay specification.**  
Failure to follow this instruction may result in insulation failure, contact melt, contact failure, relay broken, or fire

### Cautions during Use

- Follow instructions in 'Cautions during Use'. Otherwise, It may cause unexpected accidents.
- When connecting an inductive load such as DC relay or solenoid valve to the output, remove surge by using diodes or varistors.
- Use the product after 0.5 sec of the power input.  
When using a separate power supply for the sensor and load, supply power to the sensor first.
- 12-24 VDC $\equiv$  power supply should be insulated and limited voltage/current or Class 2, SELV power supply device.
- Wire as short as possible and keep it away from high voltage lines or power lines to prevent surge and inductive noise.
- When using switching mode power supply (SMPS), ground F.G. terminal and connect a condenser between 0V and F.G. terminal to remove noise.
- When using a sensor with a noise-generating equipment (e.g., switching regulator, inverter, and servo motor), ground F.G. terminal of the equipment.
- This unit may be used in the following environments.
  - Indoors (in the environment condition rated in 'Specifications')
  - Altitude max. 2,000 m
  - Pollution degree 2
  - Installation category II

### Product Components

Sensing type	Through-beam	Retroreflective	Polarized retroreflective	Diffuse reflective
<b>Product components</b>	Product, instruction manual			
Reflector	-	MS-2	MS-3	-
Adjustment screwdriver	× 1	× 1	× 1	× 1
Bracket / Z bolt	× 2	× 1	× 1	× 1
Washer	× 2	× 1	× 1	× 1
Bolt / nut	× 4	× 2	× 2	× 2
Ø 6 / Ø 10 waterproof rubber	× 2	× 1	× 1	× 1

## Ordering Information

This is only for reference, the actual product does not support all combinations. For selecting the specified model, follow the Autonics website.

**BX** ① - ② ③ - ④

### ① Sensing distance

Number: Sensing distance (unit: mm)  
Number+M: Sensing distance (unit: m)

### ② Sensing type

T: Through-beam  
M: Retroreflective  
P: Polarized retroreflective  
D: Diffuse reflective

### ③ Output method

FR: AC/DC power, relay contact output  
DT: DC power, solid state (transistor) output

### ④ Function

No mark: No function  
T: Built-in timer function

## Sold Separately

- Reflector: MS Series
- Retroreflective tape: MST Series

## Cautions during Installation

- Be sure to install this product by following the usage environment, location, and specified ratings. Consider the listed conditions below.
  - Installation environment and background (reflected light)
  - Sensing distance and sensing target
  - Direction of target's movement
  - Feature data
- When installing multiple sensors closely, it may result in malfunction due to mutual interference.
- Mount the brackets correctly to prevent the twisting of the sensor's optical axis.
- Retroreflective: If the sensing target has a glossy surface or high reflection, tilt the sensing target with an angle from 30 to 45 degrees and install the sensor.

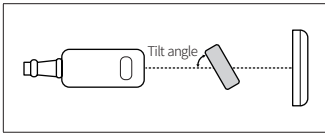

- Use this product after the test. Check whether the indicator works appropriately for the positions of the detectable object.

Through-beam	Retroreflective	Reflective
Emitter - Receiver: Install to face each other	Sensor - Reflector: At least 0.1 m apart, install to face each other (parallel with the sensing side of the unit)	Sensor - Sensing target: Install to face each other (parallel with the sensing side of the unit)

## Cautions for Wiring

- Use the round wire with the size of  $\phi 6$  to 10 mm like [Fig. 1].
- When extending the wire, use a wire of AWG 20 or higher. (extension length:  $\leq 100$  m)
- Use the wire holder, washer, and waterproof rubber together like [Fig. 2].  
Select the round wire with the size of  $\phi 6$  to 10 mm for the waterproof and tighten the cable holder by a torque of 1.0 to 1.5 N m.
- Be sure to mount the protective cover. Failure to follow this instruction may result in electric shock. Tighten the screw of protective cover by a torque of 0.3 to 0.5 N m.
- Use the UL approved stripped crimp terminal that satisfies the size of [Fig. 3].
- Tighten the terminal screw with a torque of 0.8 N m.

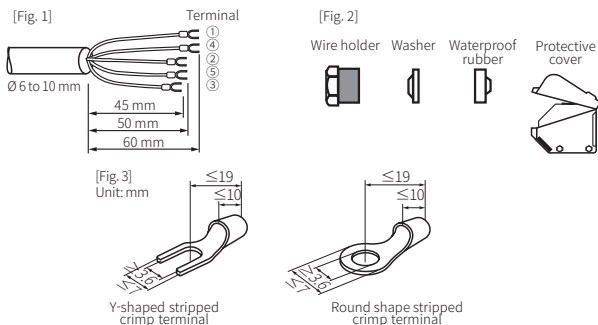

## Connections

### ■ AC/DC power, relay contact output

- Emitter

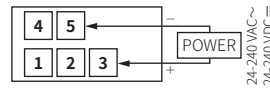

- Receiver, Retroreflective, Polarized retroreflective, Diffuse reflective type

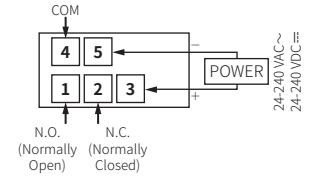

### ■ DC power, solid state (transistor) output

- Emitter

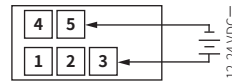

- Receiver, Retroreflective, Polarized retroreflective, Diffuse reflective type

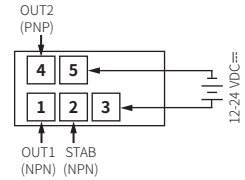

## Circuit

### ■ AC/DC power, relay contact output

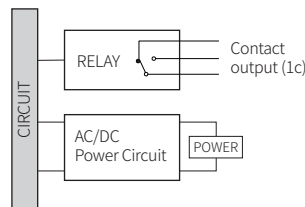

### ■ DC power, solid state (transistor) output

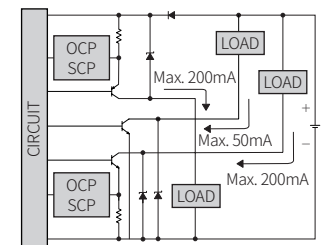

- OCP (over current protection), SCP (short circuit protection)
- If short-circuit the control output terminal or supply current over the rated specification, normal control signal is not output due to the protection circuit.

## Operation Timing Chart

### ■ Light ON mode

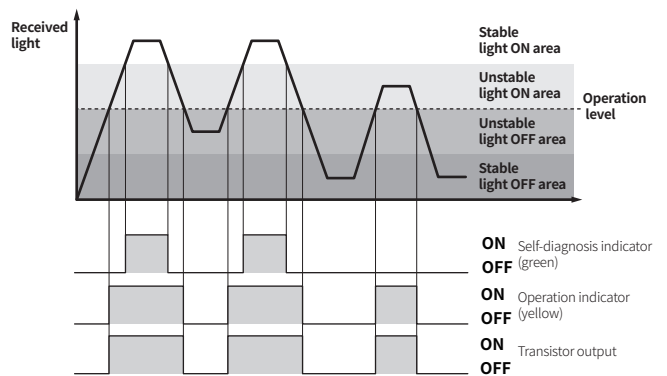

- For preventing the malfunction, the control output maintains off state for 0.5 sec after power-on.
- Timer mode: Timer OFF (SW1: ON, SW2: ON)
- In Dark ON mode, the waveforms are reversed.

## Sensitivity Adjustment

- Set the adjuster for stable Light ON area, minimizing the effect of the installation environment.
- Use the offered adjustment screwdriver. Do NOT turn with excessive force to prevent product damage.
- The steps below are based on Light ON mode.

STEP	Status	Description
01	Received	Turn the adjuster from MIN to MAX sensitivity and check the position (A) where the operation indicator activates under the light ON area.
02	Interrupted	Turn the adjuster from (A) to MAX and check the position (B) where the operation indicator activates under the light OFF area. If the operation indicator does NOT activate at the MAX (maximum sensitivity): MAX = (B).
03	-	Set the adjuster at the mid position between (A) and (B) for optimal sensitivity.

## Specifications

Model	BX15M-T□-□	BX5M-M□-□	BX3M-P□-□	BX700-D□-□
Sensing type	Through-beam	Retroreflective	Polarized retroreflective	Diffuse reflective
Sensing distance	15 m	0.1 to 5 m <sup>(01)</sup>	0.1 to 3 m <sup>(02)</sup>	700 mm <sup>(03)</sup>
Sensing target	Opaque materials	Opaque materials	Opaque materials	Opaque, translucent materials
Min. sensing target	≥ Ø 15 mm	≥ Ø 60 mm	≥ Ø 60 mm	-
Hysteresis	-	-	-	≤ 20 % of sensing distance
Response time	AC/DC power, relay contact output model: ≤ 20 ms DC power, solid state (transistor) output model: ≤ 1 ms			
Light source	Infrared	Infrared	Red	Infrared
Peak emission wavelength	850 nm	940 nm	660 nm	940 nm
Sensitivity adjustment	YES (Adjuster)	YES (Adjuster)	YES (Adjuster)	YES (Adjuster)
Timer mode <sup>(04)</sup>	OFF, ON Delay, OFF Delay, One Shot Delay mode selectable (Switch): 0.1 to 5 sec (Adjuster)			
Operation mode	Light ON mode - Dark ON mode selectable (Switch)			
Indicator	Operation indicator (yellow), self-diagnosis indicator (green), power indicator (yellow) <sup>(05)</sup>			
Approval	CE ENEC	CE ENEC	CE ENEC	CE ENEC
Unit weight	Based on the standard model, timer model: weight + 1 g			
AC/DC power	≈ 225 g	≈ 130 g	≈ 148 g	≈ 115 g
DC power	≈ 211 g	≈ 123 g	≈ 141 g	≈ 116 g

01) Reflector (MS-2)

02) Reflector (MS-3)

03) Non-glossy white paper 200 × 200 mm

04) Only for the timer model

05) Only for the emitter

Output method	AC/DC power, relay contact output	DC power, Transistor solid state output
Power supply	24-240 VAC ~ ± 10 % 50/60 Hz 24-240 VDC = ± 10 % (ripple P-P: ≤ 10 %)	12-24 VDC = ± 10 % (ripple P-P: ≤ 10 %)
Power / current consumption	≤ 3 VA	It depends on the sensing type
Through-beam		Emitter: ≤ 50 mA, receiver: ≤ 50 mA
Reflective		≤ 50 mA
Control output	Relay contact output	NPN open collector - PNP open collector simultaneous output
Contact capacity	250 VAC ~ 3 A of resistance load, 30 VDC = 3 A of resistance load	
Contact composition	1c	-
Relay life cycle	Mechanical: ≥ 50,000,000 Electrical: ≥ 100,000	
Load voltage		≤ 30 VDC =
Load current		≤ 200 mA
Residual voltage		NPN: ≤ 1 VDC =, PNP: ≤ 2.5 VDC =
Self-diagnosis output		NPN open collector output <sup>(01)</sup>
Protection circuit		Reverse power protection circuit, output short overcurrent protection circuit
Insulation resistance	≥ 20 MΩ (500 VDC = megger)	
Insulation type	Double or strong insulation (dielectric voltage between the measured input and the power: 1.5 kV)	-
Noise immunity	± 1,000 VDC = the square wave noise (pulse width: 1 μs) by the noise simulator	± 240 VDC = the square wave noise (pulse width: 1 μs) by the noise simulator
Dielectric strength	1,500 VAC ~ 50/60 Hz for 1 min	
Vibration	1.5 mm double amplitude at frequency of 10 to 55 Hz (for 1 min) in each X, Y, Z direction for 2 hours	
Vibration (malfunction)	1.5 mm double amplitude at frequency of 10 to 55 Hz (for 1 min) in each X, Y, Z direction for 10 min	
Shock	500 m/s <sup>2</sup> (≈ 50 G) in each X, Y, Z direction for 3 times	
Shock (malfunction)	100 m/s <sup>2</sup> (≈ 10 G) in each X, Y, Z direction for 3 times	
Ambient illuminance (receiver)	Sunlight: ≤ 11,000 lx, incandescent lamp: ≤ 3,000 lx	
Ambient temperature	-20 to 55 °C, storage: -25 to 70 °C (no freezing or condensation)	
Ambient humidity	35 to 85 %RH, storage: 35 to 85 %RH (no freezing or condensation)	
Protection rating	IP66 (IEC standard)	
Connection	Terminal type	
Material	Case, lens cover: PC, sensing part: Acrylic, bracket: SPCC, bolt: SCM, nut: SCM	

01) Load voltage: ≤ 30 VDC =, load current: ≤ 50 mA, residual voltage: ≤ 1 VDC = (50 mA), ≤ 0.4 VDC = (16 mA)

## Unit Descriptions

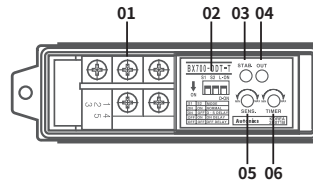

- Terminal (power, input/output)**  
Refer to the 'Connections.'
- Setting switch**  
Select L.ON (Light ON) or D.ON (Dark ON) mode.  
Built-in timer model: Configure SW1 and SW2 for setting the timer mode.
- Self-diagnosis indicator (green)**
- Operation indicator (yellow)**
- Sensitivity adjuster**
- Timer adjuster**  
(built-in timer model)

## Timer Setting

- Built-in timer model: Configure the timer switch (SW1 + SW2) for setting the timer mode.
- Use offered adjustment screwdriver for timer adjuster. (setting range: 0.1 to 5 sec)  
Do NOT turn with excessive force to prevent product damage.
- During the operation of timer mode, conversion to other timer modes is applied after a former mode is finished.

Timer mode	Switch		Operation mode	Received Interrupted	Timing Diagram
	SW1	SW2			
Timer OFF	ON	ON	Light ON	ON OFF	[Timing Diagram]
		OFF	Dark ON	ON OFF	[Timing Diagram]
One Shot Delay Mode	ON	OFF	Light ON	ON OFF	[Timing Diagram]
		ON	Dark ON	ON OFF	[Timing Diagram]
ON Delay Mode	OFF	ON	Light ON	ON OFF	[Timing Diagram]
		OFF	Dark ON	ON OFF	[Timing Diagram]
OFF Delay Mode	OFF	OFF	Light ON	ON OFF	[Timing Diagram]
		ON	Dark ON	ON OFF	[Timing Diagram]

T: Time set by timer adjuster.

## Dimensions

- Unit: mm, For the detailed drawings, follow the Autonics website.

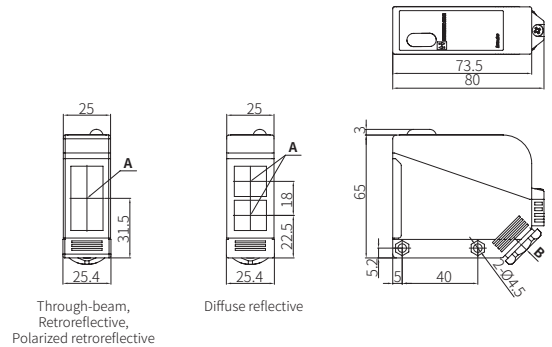

Through-beam, Retroreflective, Polarized retroreflective

Diffuse reflective

A	Optical axis	B	22 mm hexagonal nut
---	--------------	---	---------------------

### Reflector (MS-2)

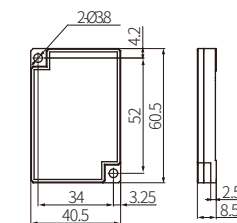

### Reflector (MS-3)

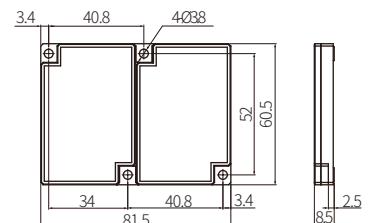

### Bracket

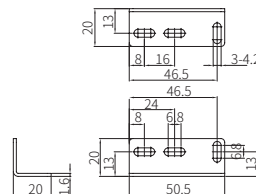

## Feature Data: Through-beam Type

### Sensing area

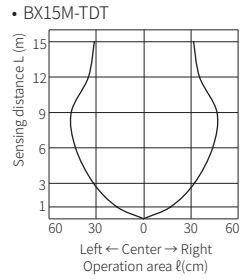
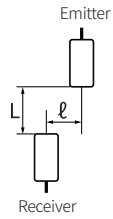

### Emitter angle

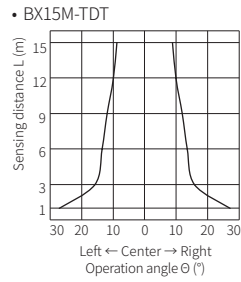
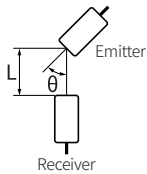

## Feature Data: Polarized Retroreflective Type

### Sensing area

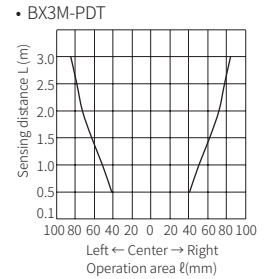
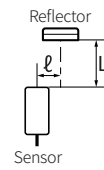

### Sensor angle

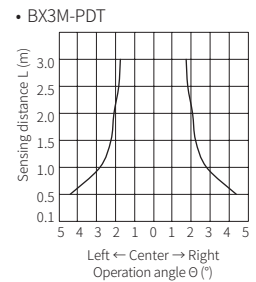
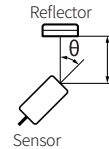

## Feature Data: Retroreflective Type

### Sensing area

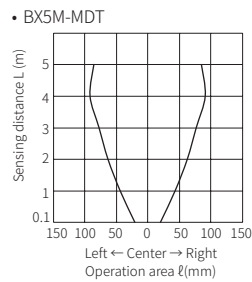
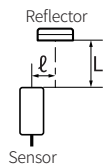

### Sensor angle

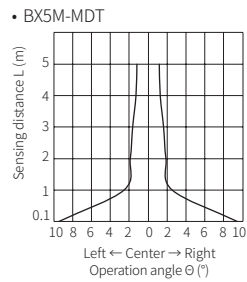
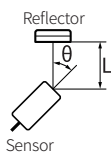

### Reflector angle

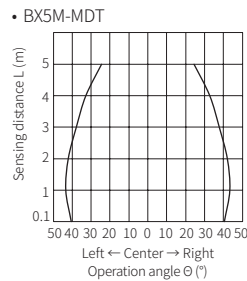
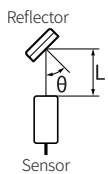

### Reflector angle

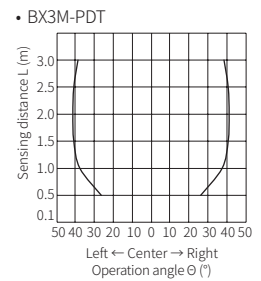
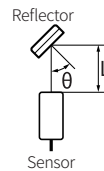

## Feature Data: Diffuse Reflective Type

### Sensing area

