

Dual Display Fiber Optic Amplifiers



BFX Series PRODUCT MANUAL

For your safety, read and follow the considerations written in the instruction manual, other manuals and Autonics website.

The specifications, dimensions, etc. are subject to change without notice for product improvement. Some models may be discontinued without notice.

Features

- Dual-display for light incident level and setting value
- Enables to detect the minute object with 1/10,000 high resolution
- Enables to detect with high-speed moving object (response time 50 μ s)
- 5 response times
 - : ultra fast mode (50 μ s), fast mode (150 μ s), standard mode (500 μ s), long distance mode (4 ms), ultra long distance mode (10 ms)
- Anti-saturation setting function prevents malfunction by saturated light
- External input
 - : emitter OFF, remote sensitivity setting, peak reset, output ON/OFF/Keep, energy saving OFF
- Multiple sensitivity setting modes available
 - : auto tuning (fine-adjusting sensitivity)
 - teaching sensitivity setting (button or external input auto-tuning, 1-point, 2-point, positioning)

Safety Considerations

- Observe all 'Safety Considerations' for safe and proper operation to avoid hazards.
- \triangle symbol indicates caution due to special circumstances in which hazards may occur.

\triangle Warning Failure to follow instructions may result in serious injury or death.

- 01. Fail-safe device must be installed when using the unit with machinery that may cause serious injury or substantial economic loss.**(e.g., nuclear power control, medical equipment, ships, vehicles, railways, aircraft, combustion apparatus, safety equipment, crime/disaster prevention devices, etc.)
Failure to follow this instruction may result in personal injury, economic loss or fire.
- 02. Do not use the unit in the place where flammable/explosive/corrosive gas, high humidity, direct sunlight, radiant heat, vibration, impact or salinity may be present.**
Failure to follow this instruction may result in explosion or fire.
- 03. Install the unit on DIN rail to use.**
Failure to follow this instruction may result in fire.
- 04. Do not disassemble or modify the unit.**
Failure to follow this instruction may result in fire.
- 05. Do not connect, repair, or inspect the unit while connected to a power source.**
Failure to follow this instruction may result in fire.
- 06. Check 'Connections' before wiring.**
Failure to follow this instruction may result in fire.

\triangle Caution Failure to follow instructions may result in injury or product damage.

- 01. Use the unit within the rated specifications.**
Failure to follow this instruction may result in fire or product damage.
- 02. Use a dry cloth to clean the unit, and do not use water or organic solvent.**
Failure to follow this instruction may result in fire.

Cautions during Use

- Follow instructions in 'Cautions during Use'. Otherwise, it may cause unexpected accidents.
- When connecting an inductive load such as a DC relay, remove surge by using a diode or varistor.
- Use the product after 3 sec of the power input.
- The power supply should be insulated and limited voltage/current or Class 2, SELV power supply device.
- If the supplying power is out of the rated power supply, the internal power supply is unstable, causing product malfunction. Use the product within the rated specification range.
- Wire as short as possible and keep it away from high voltage lines or power lines to prevent surge and inductive noise.
- When using switching mode power supply (SMPS), ground F.G. terminal and connect a condenser between 0V and F.G. terminal to remove noise.
- Since external disturbance light (sunlight, fluorescent lighting, etc.) can cause product malfunction, use the product with a light shield or slit.
- When sensing an object with the maximum sensitivity, an error of sensing distance can occur due to the deviation of each feature.
- Turn off the power of the fiber optic amplifier before installation or removal.
- When installing the fiber optic unit, check the bend radius of each unit written on the product manual. If the installed unit that has the bend radius under the rated range, causing optical loss so the sensing distance is shortened.
- Be sure not to scratch the surface of the fiber optic unit.
- Do not pull the cable of the fiber optic unit that is connected to the amplifier.
- This unit may be used in the following environments.
 - Indoors (in the environment condition rated in 'Specifications')
 - Altitude max. 2,000 m
 - Pollution degree 2
 - Installation category III

Ordering Information

This is only for reference, the actual product does not support all combinations.
For selecting the specified model, follow the Autonics website.

BFX - D1 - ①

① Control output

N: NPN open collector output

P: PNP open collector output

Product Components

- Product
- Connector cable
- Instruction manual

Sold Separately

- Fiber optic units

Connections

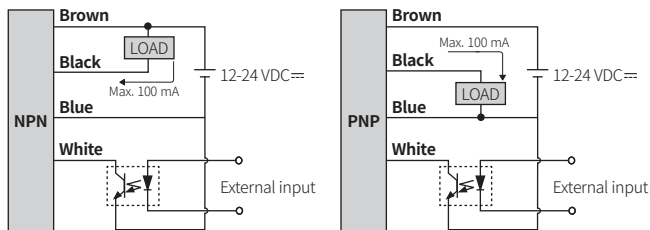

- The duration of a signal over 2 ms is necessary for the external input function.
For using the external input, use a photocoupler or external controller, etc.
Otherwise, it may result in product damage.

Circuit

■ NPN open collector output

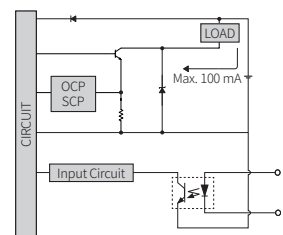

■ PNP open collector output

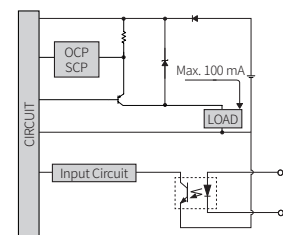

- OCP (over current protection), SCP (short circuit protection)

Dimensions

- Unit: mm, For the detailed drawings, follow the Autonics website.

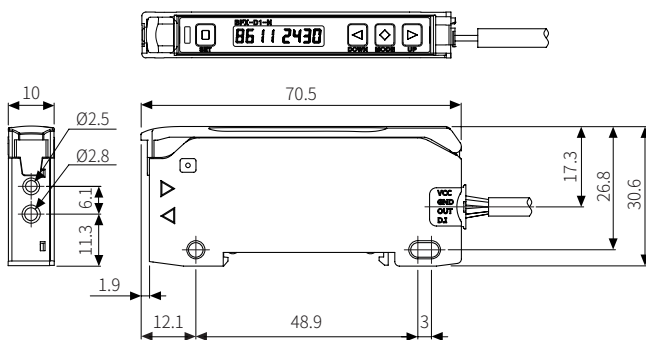

Error

Error	Cause	Troubleshooting
Err	In RUN mode, the overcurrent has been detected from the output circuit.	Remove the overcurrent due to the overload.

Specifications

Model	BFX-D1-□
Light source	Red LED
Peak emission wavelength	660 nm, modulated
Response time	Standard (500 μs), Long distance (4 ms), Ultra long distance (10 ms), Ultra fast (50 μs), Fast (150 μs) mode
Sensitivity setting	Manual, Teaching (Auto-tuning, 1-point, 2-point, positioning)
Operation mode	Light ON, Dark ON
Measured value display	7-segment LCD, 4-digit (decimal, percentage)
Operation mode of the timer	OFF, OFF Delay, ON Delay, One-shot
External input	Teaching sensitivity, initialization of the incident light level, emitter OFF, control output setting, energy saving mode release
Indicator	Operation indicator (red), display screen (PV display part: red LED, SV display part: green LED)
Approval	CE ENEC
Unit weight (packaged)	≈ 16 g (≈ 115 g)

Power supply	12-24 VDC± ±10% (ripple P-P: ≤ 10%)
Current consumption	≤ 50 mA
Control output	NPN open collector output / PNP open collector output model
Load voltage	≤ 24 VDC±
Load current	≤ 100 mA
Residual voltage	NPN: ≤ 1 VDC±, PNP: ≤ 3 VDC±
Protection circuit	Reverse power protection circuit, output short overcurrent protection circuit, surge protection circuit
Insulation resistance	≥ 20 MΩ (500 VDC± megger)
Dielectric strength	1,000 VAC~ 50 / 60 Hz for 1 min
Vibration	1 mm double amplitude at frequency 10 to 55 Hz (for 1 min) in each X, Y, Z direction for 2 hours
Shock	500 m/s ² (≈ 50 G) in each X, Y, Z direction for 3 times
Ambient illuminance (receiver)	Sunlight: ≤ 11,000 lx, incandescent lamp: ≤ 3,000 lx
Ambient temperature (01)	-10 to 50 °C, storage: -20 to 70 °C (no freezing or condensation)
Ambient humidity	35 to 85%RH, storage: 35 to 85%RH (no freezing or condensation)
Protection rating	IP40 (IEC standard)
Connection	Connector cable
Cable spec.	∅ 4 mm, 4-wire, 2 m
Wire spec.	AWG22 (0.08 mm, 60-core), insulator outer diameter: ∅ 1.25 mm
Tightening torque for fiber optic unit	≥ 2kgf
Material	Case: POK, cover: PC

- 01) 1 to 2 units: -10 to 50 °C, 3 to 8 units: -10 to 35 °C
Be cautious about the heat transfer when the number of connected units is more than 8.
The ambient temperature varies with the number of connected amplifiers that are mounted on the DIN rail.
Be sure to check the temperatures when installing in the enclosed area.

Enter the Mode

- For more detailed information on functions and settings, refer to the manual.

RUN	[MODE] 3 sec →	Program mode	[MODE] 3 sec →	RUN
	[SET] →	Teaching sensitivity setting	Auto →	
	[◀] + [▶] →	Manual sensitivity setting	[MODE] or after 3 sec →	
	[SET] + [▶] →	Anti-saturation function	Auto →	
	[MODE] →	Incident light level monitoring	[MODE] →	
	[MODE] 7 sec →	Initialization	Auto →	

DIN Rail Mount and Removal

■ Mount

- Hang up the holder on the backside of the amplifier to the DIN rail (35 mm).
- Press the front side of the amplifier toward the DIN rail.

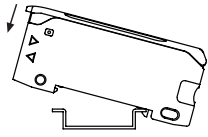

■ Removal

- Slide the amplifier to direction ①.
- Lift the front side of the amplifier to direction ②.

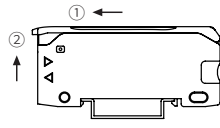

Insert Fiber Optic Unit

- Lift the protective cover and lower down the lever lock.
- Insert the cable of the fiber optic unit to the slot completely.
(▷ : receiver part, ◁ : emitter part)

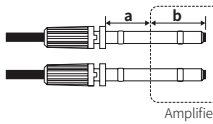

Length (mm)	Receiver part	Emitter part
a ⁰¹⁾	13	14
b	8	7

01) With the adaptor attached

- Lift the lever lock to fix the fiber optic unit and close the protective cover.

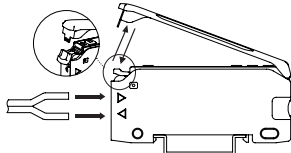

Connect and Remove Connector Cable

■ Connection

Insert the connector into the amplifier mounted to DIN rail with a click.

■ Removal

Press the connector part to direction ① and pull it.

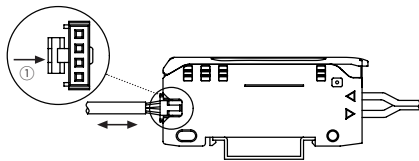

Unit Descriptions

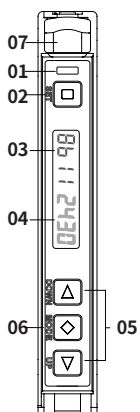

- Operation indicator (red)**
ON or OFF depending on the operation mode
- [SET] key**
Teaching sensitivity setting, incident light level monitoring
- PV display part (red 4-digit LED)**
RUN mode: it shows PV (present value).
Setting mode: it shows the parameter.
- SV display part (green 4-digit LED)**
RUN mode: it shows SV (setting value).
Setting mode: it shows the setting value, parameter value.
- [◀|▶] key**
Manual sensitivity setting, selecting the setting value
- [MODE] key**
Enter mode, return to RUN mode, move parameter, save the setting value
- Lever lock**
It is used to fix the fiber optic unit.

Program Mode

- Activate or deactivate some of the parameters depending on other parameter settings. Refer to the detailed explanation of each mode.
- Return to RUN mode for applying the setting.
- [MODE] key: saves the setting value and move to the next parameter
- [◀], [▶] key: selects the setting value and time of the timer

Mode	Display	Factory defaults		Setting range
		PV	SV	
P	Program mode	Prog	mode	<ul style="list-style-type: none"> Entering method: in RUN mode, [MODE] key 3 sec
P-1	Response time	rspd	std	<ul style="list-style-type: none"> STD: standard mode (500 μs) LONG: long distance mode (4 ms) ULOG: ultra long distance mode (10 ms) UFST: ultra fast mode (50 μs) FST: fast mode (150 μs)
P-2	Teaching mode	SENS	Auto	<ul style="list-style-type: none"> AUTO: auto-tuning 1PNT: 1-point teaching 2PNT: 2-point teaching PSTN: positioning teaching • Refer to the 'Teaching sensitivity setting.'
P-3	Operation mode	Ldon	L-on	<ul style="list-style-type: none"> L-ON (Light ON): when the light is received state, operation indicator turns ON D-ON (Dark ON): when the light is interrupted state, operation indicator turns ON
P-4	Measured value display ⁰¹⁾	dSPF	4000	<ul style="list-style-type: none"> 4000: decimal 999P: percentage
P-5	Display direction	dir	1234	<ul style="list-style-type: none"> 1234: normal ƆƆ1: upside down
P-6	Operation mode of the timer	tnod	off	<ul style="list-style-type: none"> OFF ON_D: delays OFF → ON timing of the control output (ON delay) OF_D: delays ON → OFF timing of the control output (OFF delay) SHOT: maintains ON state of the control output during the setting time (One-shot) • Refer to the 'Timing Chart of the Timer.'
P-7	Time of the timer ⁰²⁾	tiNE	2000	1 to 5,000 ms
P-8	External input	d-in	off	<ul style="list-style-type: none"> OFF: not used SET: teaching sensitivity setting RST: initializes the values of the incident light level monitoring T_OF: emitter OFF function PAUS: control output setting SLEP: energy saving mode release
P-9	Control output ⁰³⁾	PAUS	-	<ul style="list-style-type: none"> KEEP: maintains the state of the control output ON: the control output is ON OFF: the control output is OFF • Refer to the 'Timing Chart of the Control Output.'
P-10	Energy saving mode	ESAw	off	<ul style="list-style-type: none"> OFF: not used HALF: OFF the SV display part without pressing the key over 1 min FULL: OFF the display screen without pressing the key over 1 min
P-11	Lock mode	LOCt	off	<ul style="list-style-type: none"> OFF LOC1 LOC2 • Refer to the [Table 1] below.

01) Decimal range: 0 to 4000 (in case of the long-distance mode in the response time : 0 to 9999)
Percentage range: 0 to 999P (no decimal points)

02) Display condition: all but OFF of the timer operation mode

03) Display condition: external input-control output setting (PAUS)

• [Table 1]

Parameter	LOC 1		LOC 2	
	Check	Setting	Check	Setting
Sensitivity setting	○	X	○	X
Program mode	○	X	X	X
External input setting	X	X	X	X
Anti-saturation function	X	X	X	X
Initialization	X	X	X	X

Timing Chart of the Timer

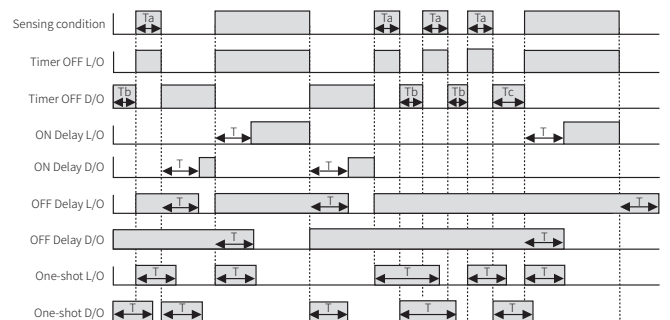

• T: setting time (T > Ta, T > Tb, T > Tc > Tb)

Timing Chart of the Control Output

- The settings of the control output: KEEP, ON, OFF
- External input time: ≥ 2 ms

KEEP

When the external input is applied, maintaining the state of the control output (a).

a = ON

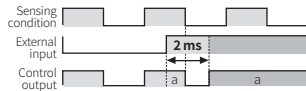

a = OFF

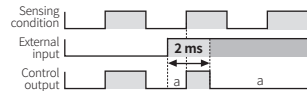

ON

The control output is ON state under the external input time.

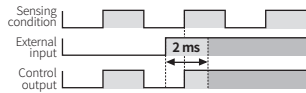

OFF

The control output is OFF state under the external input time.

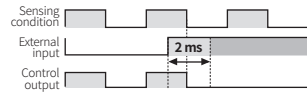

Teaching Selection

Auto-tuning

It is suitable for the sensing environment in which fast-moving objects make unstable incident light levels. Also, it is convenient because the object maintains its movement continuously during the teaching mode. It uses the average value of the incident light level estimated a certain period of time.

1-point teaching

It is suitable for the sensing environment where much dust or pollutant makes the lower incident level. The teaching proceeds; through-beam type: with sensing target, reflective type: without sensing target

2-point teaching

It is suitable for the sensing environment in which the object moves slowly or stops with stable incident light level. After the teaching 2 points (with/without sensing target), set the average value as a teaching value.

Positioning teaching

After placing the sensing target to the desired position, set 90% of the incident light level as a teaching value. Typically, it is available for detecting a small hole on the surface (through-beam type) or detecting moving object having a curve (reflective type).

Teaching Sensitivity Setting

- Before setting the sensitivity, select the teaching mode suitable for the sensing environment. Refer to the detailed explanation of the teaching mode.
- To use the teaching sensitivity setting by external input, select P-8. External input to the teaching sensitivity setting (SET).

Mode	PV	SV	Descriptions
Auto-tuning	RULt a	1 - 5	Press [SET] key to proceed the teaching: 2 sec
		2 - 5	
		a E	
1-point teaching ⁽⁰¹⁾	1Pnt t	1 - 5	Press [SET] key to proceed the teaching: 2 sec
		2 - 5	
		a E	
2-point teaching ⁽⁰²⁾	2Pnt t	1P	Press [SET] key to enter 1-point teaching mode
		1 - 5	1-point teaching : without sensing target
		2 - 5	Press [SET] key to proceed teaching : 2 sec
		1P a E	Cross-flashing twice (e.g., 1-point teaching value (P _{min}) = 250)
		2P	Standby 2-point teaching
		1 - 5	2-point teaching : with sensing target
		2 - 5	Press [SET] key to proceed the teaching : 2 sec (without pressing key over 1 min: end teaching and return to RUN mode)
		2P a E	Cross-flashing twice (e.g., 2-point teaching value (P _{max}) = 3400)
3400			
Positioning teaching	P5t n	1 - 5	Press [SET] key to proceed teaching: 2 sec
		2 - 5	
		a E	
		1B25	Completion (e.g., teaching value ($\frac{P_{min} + P_{max}}{2}$) = 1825)

(01) Adjust incident light level depending on the response time. Refer to the table below.

Response time	Incident light level	
	0	Saturation
Ultra fast mode	10	3980
Fast mode		
Standard (STD) mode		
Long distance mode	5	9980
Ultra long distance mode		

(02) Based on the reflective type.

Manual Sensitivity Setting

- You can set the sensitivity as the desired value. (factory defaults: 2000)
- You can adjust the teaching value from the teaching sensitivity setting.
- PV display part shows the present incident light level during the manual sensitivity setting.

Mode	PV	SV	Descriptions
RUN mode	3210	3000	Change the setting value using [◀], [▶] key (e.g., 3000 → 2500)
Sensitivity setting	3210	2500	Press [MODE] key or without pressing a key over 3 sec, flashing the setting value twice (save the setting value) and return to RUN mode

Anti-saturation Function

- When the incident light level is saturated, optimizing this value automatically (max. 10 levels).
- The anti-saturation function may change the operation of the control output.

Mode	PV	SV	Descriptions
RUN mode	4000	2000	Press [SET] + [▶] key to activate the function
ON	1000	- - - 1	Adjust the incident light level (e.g., 3 levels)
	1700	- - - 2	
	2000	- - - 3	
OFF	2000	- - o E	Flash twice and complete the setting ⁽⁰¹⁾ , return to RUN mode
	2100	2000	Press [SET] + [▶] key to deactivate the function
	4000	5 - o F	Flash twice and release the function, return to RUN mode

(01) The condition for setting completion differs depending on the response time.

Response time	Condition for the setting completion
Ultra fast mode	Incident light level $\geq 2,000$
Fast mode	
Standard (STD) mode	
Long distance mode	Incident light level $\geq 5,000$
Ultra long distance mode	

Incident Light Level Monitoring

- You can check the high peak and low peak values of the incident light level and change them to the currently measured values.

Mode	PV	SV	Descriptions
Incident light level monitoring			• Entering method: in RUN mode, press [MODE] key once
Max. value (High peak)	HPE E	4000	Check max. incident light level and press [SET] key to change (e.g., 4000 → 3000)
	HPE E	3000	Press [MODE] key to move the parameter
Min. value (Low peak)	LPE E	1000	Check min. incident light level and press [SET] key to change (e.g., 1000 → 950)
	LPE E	950	Press [MODE] key and return to RUN mode

Reset to Factory Settings

- Restore the setting value to the factory default settings. (except the incident light level monitoring)
- [◀], [▶] key: select the setting value

Mode	PV	SV	Descriptions
Initialization	i n i t		• Entering method: in RUN mode, press [MODE] key for 7 sec
		n o	Press [MODE] key and return to RUN mode
		Y E S	Press [SET] key to proceed
		i n i t	Flash twice (initialization) and return to RUN mode

Segment Table

The segments displayed on the product indicate the following meanings.
It may differ depending on the product.

7 segment				11 segment				12 segment				16 segment			
0	0	l	l	0	0	l	l	0	0	l	l	0	0	l	l
1	1	l	J	l	1	l	J	l	1	l	J	l	1	l	J
2	2	l	K	l	2	l	K	l	2	l	K	l	2	l	K
3	3	l	L	l	3	l	L	l	3	l	L	l	3	l	L
4	4	l	M	l	4	l	M	l	4	l	M	l	4	l	M
5	5	l	N	l	5	l	N	l	5	l	N	l	5	l	N
6	6	o	O	6	6	o	O	6	6	o	O	6	6	o	O
7	7	P	P	7	7	P	P	7	7	P	P	7	7	P	P
8	8	q	Q	8	8	q	Q	8	8	q	Q	8	8	q	Q
9	9	r	R	9	9	r	R	9	9	r	R	9	9	r	R
A	A	S	S	A	A	S	S	A	A	S	S	A	A	S	S
b	B	t	T	b	B	t	T	b	B	t	T	b	B	t	T
c	C	u	U	c	C	u	U	c	C	u	U	c	C	u	U
d	D	v	V	d	D	v	V	d	D	v	V	d	D	v	V
E	E	w	W	E	E	w	W	E	E	w	W	E	E	w	W
F	F	x	X	F	F	x	X	F	F	x	X	F	F	x	X
G	G	y	Y	G	G	y	Y	G	G	y	Y	G	G	y	Y
H	H	z	Z	H	H	z	Z	H	H	z	Z	H	H	z	Z